

LMZ23605

LMZ23605 5A SIMPLE SWITCHER® Power Module with 36V Maximum Input Voltage



Literature Number: SNVS659D

LMZ23605

5A SIMPLE SWITCHER® Power Module with 36V Maximum Input Voltage

Easy To Use 7 Pin Package

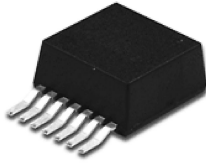

Top View

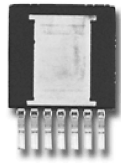

Bottom View

TO-PMOD 7 Pin Package
 10.16 x 13.77 x 4.57 mm (0.4 x 0.542 x 0.18 in)
 $\theta_{JA} = 12^{\circ}\text{C/W}$, $\theta_{JC} = 1.9^{\circ}\text{C/W}$ (Note 6)
 RoHS Compliant

30116986

Electrical Specifications

- 30W maximum total output power
- Up to 5A output current
- Input voltage range 6V to 36V
- Output voltage range 0.8V to 6V
- Efficiency up to 92%

Key Features

- Integrated shielded inductor
- Simple PCB layout
- Frequency synchronization input (650 kHz to 950 kHz)
- Flexible startup sequencing using external soft-start, tracking and precision enable
- Protection against inrush currents and faults such as input UVLO and output short circuit
- -40°C to 125°C junction temperature range
- Single exposed pad and standard pinout for easy mounting and manufacturing
- Fast transient response for powering FPGAs and ASICs
- Fully enabled for Webench® Power Designer
- Pin compatible with LMZ22005/LMZ23603/LMZ22003

Applications

- Point of load conversions from 12V and 24V input rail
- Time critical projects
- Space constrained / high thermal requirement applications
- Negative output voltage applications See AN-2027

Performance Benefits

- High efficiency reduces system heat generation
- Complies with EN55022 Class B (Note 5)
- Low component count, only 5 external components
- Low output voltage ripple
- Uses PCB as heat sink, no airflow required

System Performance

Efficiency $V_{IN} = 12\text{V}$ $V_{OUT} = 5.0\text{V}$

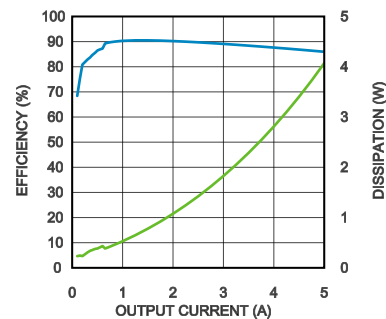

30116903

Thermal Derating Curve
 $V_{IN} = 12\text{V}$ $V_{OUT} = 5.0\text{V}$

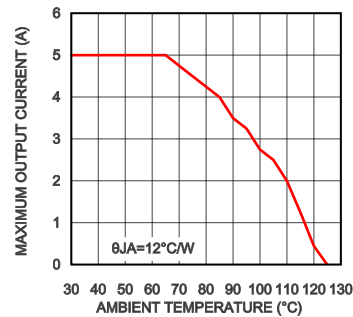

30116989

Radiated EMI (EN 55022)
 of Demo Board (See AN-2125)

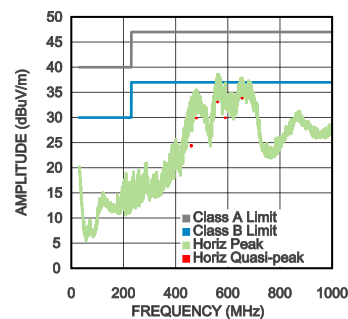

30116995

Simplified Application Schematic

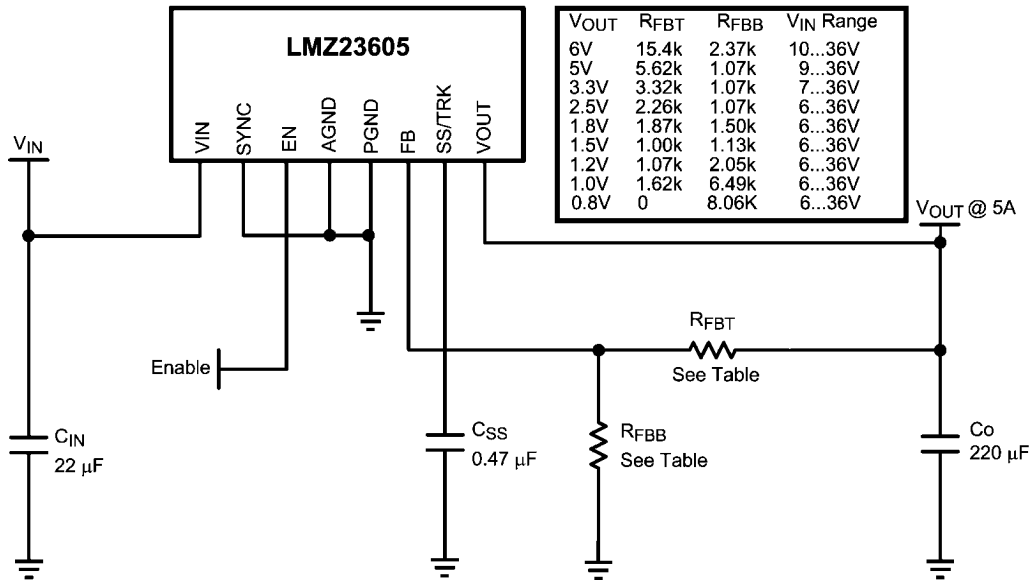

30116901

Connection Diagram

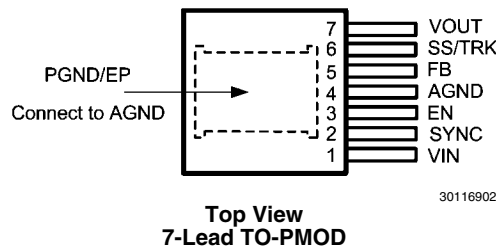

30116902

Ordering Information

Order Number	Package Type	NSC Package Drawing	Supplied As
LMZ23605TZ	TO-PMOD-7	TZA07A	45 Units in a Rail
LMZ23605TZE	TO-PMOD-7	TZA07A	250 Units on Tape and Reel
LMZ23605TZX	TO-PMOD-7	TZA07A	500 Units on Tape and Reel

Pin Descriptions

Pin	Name	Description
1	VIN	Supply input — Nominal operating range is 6V to 36V . A small amount of internal capacitance is contained within the package assembly. Additional external input capacitance is required between this pin and exposed pad (PGND).
2	SYNC	Sync Input — Apply a CMOS logic level square wave whose frequency is between 650 kHz and 950 kHz to synchronize the PWM operating frequency to an external frequency source. When not using synchronization connect to ground. The module free running PWM frequency is 812 kHz (Typ).
3	EN	Enable — Input to the precision enable comparator. Rising threshold is 1.279V typical. Once the module is enabled, a 21 uA source current is internally activated to facilitate programmable hysteresis.
4	AGND	Analog Ground — Reference point for all stated voltages. Must be externally connected to PGND (EP).
5	FB	Feedback — Internally connected to the regulation amplifier, over-voltage comparators. The regulation reference point is 0.796V at this input pin. Connect the feedback resistor divider between the output and AGND to set the output voltage.

Pin	Name	Description
6	SS/ TRK	Soft-Start/Track — To extend the 1.6 mSec internal soft-start connect an external soft start capacitor. For tracking connect to an external resistive divider connected to a higher priority supply rail. See applications section
7	VOUT	Output Voltage — Output from the internal inductor. Connect the output capacitor between this pin and exposed pad.
EP	PGND	Exposed Pad / Power Ground Electrical path for the power circuits within the module. — NOT Internally connected to AGND / pin 4. Used to dissipate heat from the package during operation. Must be electrically connected to pin 4 external to the package.

Absolute Maximum Ratings *(Note 1)*

If Military/Aerospace specified devices are required, please contact the National Semiconductor Sales Office/ Distributors for availability and specifications.

V _{IN} to PGND	-0.3V to 40V
EN, SYNC to AGND	-0.3V to 5.5V
SS/TRK, FB to AGND	-0.3V to 2.5V
AGND to PGND	-0.3V to 0.3V
Junction Temperature	150°C
Storage Temperature Range	-65°C to 150°C

ESD Susceptibility *(Note 2)*

± 2 kV

For soldering specifications: see product folder at www.national.com and www.national.com/ms/MS/MS-SOLDERING.pdf

Operating Ratings *(Note 1)*

V _{IN}	6V to 36V
EN, SYNC	0V to 5.0V
Operation Junction Temperature	-40°C to 125°C

Electrical Characteristics

Limits in standard type are for T_J = 25°C only; limits in boldface type apply over the junction temperature (T_J) range of -40°C to +125°C. Minimum and Maximum limits are guaranteed through test, design or statistical correlation. Typical values represent the most likely parametric norm at T_J = 25°C, and are provided for reference purposes only. Unless otherwise stated the following conditions apply: V_{IN} = 12V, V_{out} = 3.3V

Symbol	Parameter	Conditions	Min <i>(Note 3)</i>	Typ <i>(Note 4)</i>	Max <i>(Note 3)</i>	Units
SYSTEM PARAMETERS						
Enable Control						
V _{EN}	EN threshold trip point	V _{EN} rising	1.10	1.279	1.458	V
V _{EN-HYS}	EN input hysteresis current	V _{EN} > 1.279V		-21		µA
Soft-Start						
I _{SS}	SS source current	V _{SS} = 0V	40	50	60	µA
t _{SS}	Internal soft-start interval			1.6		msec
Current Limit						
I _{CL}	Current limit threshold	d.c. average	5.4			A
Internal Switching Oscillator						
f _{osc}	Free-running oscillator frequency	Sync input connected to ground.	711	812	914	kHz
f _{sync}	Synchronization range		650		950	kHz
V _{IL-sync}	Synchronization logic zero amplitude	Relative to AGND			0.4	V
V _{IH-sync}	Synchronization logic one amplitude	Relative to AGND.	1.5			V
Sync _{d.c.}	Synchronization duty cycle range		15	50	85	%
D _{max}	Maximum Duty Factor			83		%
Regulation and Over-Voltage Comparator						
V _{FB}	In-regulation feedback voltage	V _{SS} >+ 0.8V I _O = 5A	0.776	0.796	0.816	V
V _{FB-OV}	Feedback over-voltage protection threshold			0.86		V
I _{FB}	Feedback input bias current			5		nA
I _Q	Non Switching Input Current	V _{FB} = 0.86V		2.6		mA
I _{SD}	Shut Down Quiescent Current	V _{EN} = 0V		70		µA
Thermal Characteristics						
T _{SD}	Thermal Shutdown	Rising		165		°C
T _{SD-HYST}	Thermal shutdown hysteresis	Falling		15		°C
θ _{JA}	Junction to Ambient <i>(Note 6)</i>	4 layer Evaluation Printed Circuit Board, 60 vias, No air flow		12.0		°C/W
		2 layer JEDEC Printed Circuit Board, No air flow		21.5		°C/W
θ _{JC}	Junction to Case	No air flow		1.9		°C/W

Symbol	Parameter	Conditions	Min (Note 3)	Typ (Note 4)	Max (Note 3)	Units
PERFORMANCE PARAMETERS (Note 7)						
ΔV_O	Output voltage ripple	Cout = 220uF w/ 7 milliohm ESR + 100uF X7R + 2 x 0.047uF BW @ 20 MHz		9		mV _{PP}
$\Delta V_O/\Delta V_{IN}$	Line regulation	$V_{IN} = 12V$ to $36V$, $I_O = 0.001A$		± 0.02		%
$\Delta V_O/\Delta I_{OUT}$	Load regulation	$V_{IN} = 12V$, $I_O = 0.001A$ to $5A$		1		mV/A
η	Peak efficiency	$V_{IN} = 12V$ $V_O = 3.3V$ $I_O = 1A$		86		%
η	Full load efficiency	$V_{IN} = 12V$ $V_O = 3.3V$ $I_O = 5A$		81.5		%
η	Peak efficiency	$V_{IN} = 24V$ $V_O = 3.3V$ $I_O = 2A$		80		%
η	Full load efficiency	$V_{IN} = 24V$ $V_O = 3.3V$ $I_O = 5A$		76		%

Note 1: Absolute Maximum Ratings are limits beyond which damage to the device may occur. Operating Ratings are conditions under which operation of the device is intended to be functional. For guaranteed specifications and test conditions, see the Electrical Characteristics.

Note 2: The human body model is a 100pF capacitor discharged through a 1.5 k Ω resistor into each pin. Test method is per JESD-22-114.

Note 3: Min and Max limits are 100% production tested at 25°C. Limits over the operating temperature range are guaranteed through correlation using Statistical Quality Control (SQC) methods. Limits are used to calculate National's Average Outgoing Quality Level (AOQL).

Note 4: Typical numbers are at 25°C and represent the most likely parametric norm.

Note 5: EN 55022:2006, +A1:2007, FCC Part 15 Subpart B: 2007. See AN-2125 and layout for information on device under test. $V_{IN} = 24V$ $V_O = 3.3V$ $I_O = 5A$

Note 6: Theta JA measured on a 3.5" x 3.5" four layer board, with three ounce copper on outer layers and two ounce copper on inner layers, sixty 10 mil thermal vias, no air flow, and 1W power dissipation. Refer to application note layout diagrams.

Note 7: Refer to BOM in Table 1.

Typical Performance Characteristics

Unless otherwise specified, the following conditions apply: $V_{IN} = 12V$; $C_{in} = 2 \times 10\mu F + 1\mu F$ X7R Ceramic; $C_O = 220\mu F$ Specialty Polymer + $10 \mu F$ Ceramic; $T_{Ambient} = 25^\circ C$ for waveforms. Efficiency and dissipation plots marked with * have cycle skipping at light loads resulting in slightly higher Output ripple – See applications section.

Efficiency 6.0V Output @ 25°C Ambient

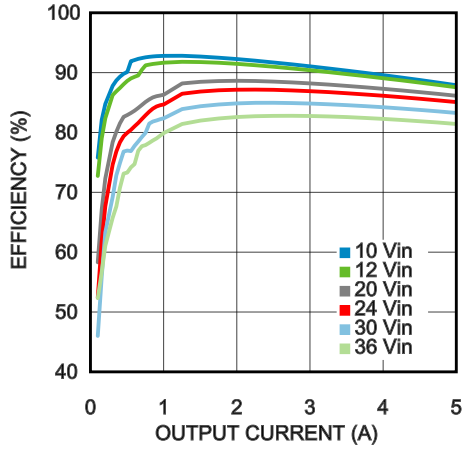

30116987

Dissipation 6.0V Output @ 25°C Ambient

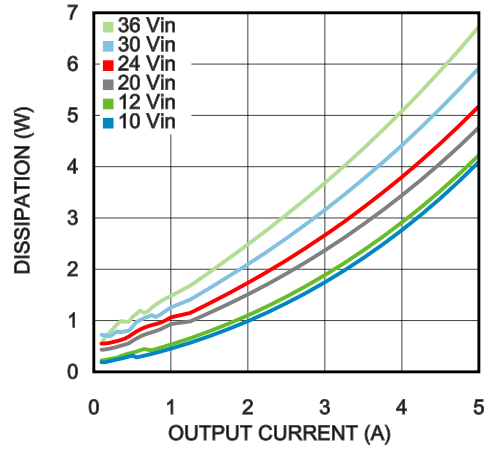

30116988

Efficiency 5.0V Output @ 25°C Ambient

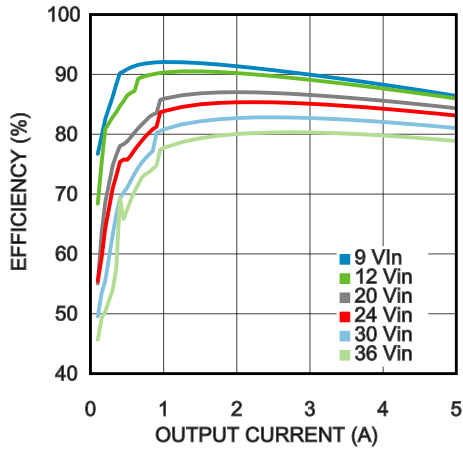

30116952

Dissipation 5.0V Output @ 25°C Ambient

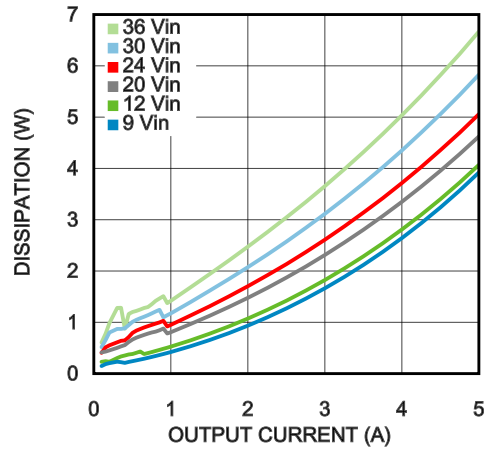

30116953

Efficiency 3.3V Output @ 25°C Ambient

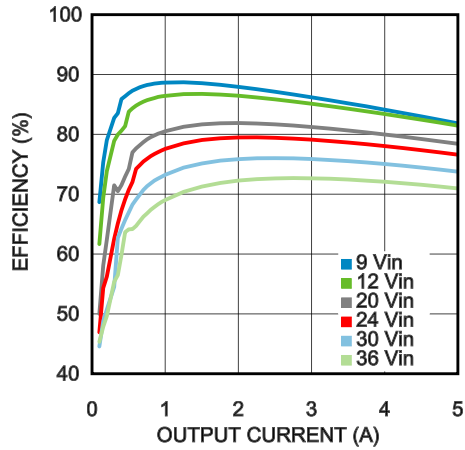

30116954

Dissipation 3.3V Output @ 25°C Ambient

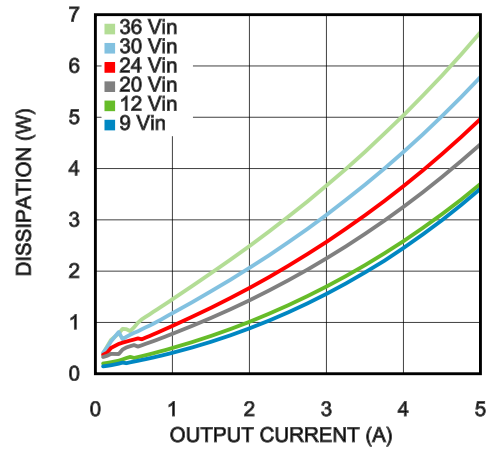

30116955

Efficiency 2.5V Output @ 25°C Ambient

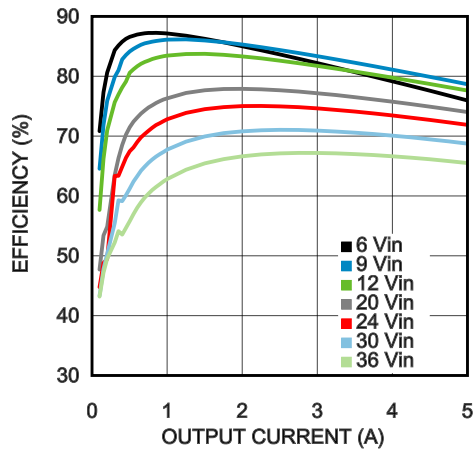

30116956

Dissipation 2.5V Output @ 25°C Ambient

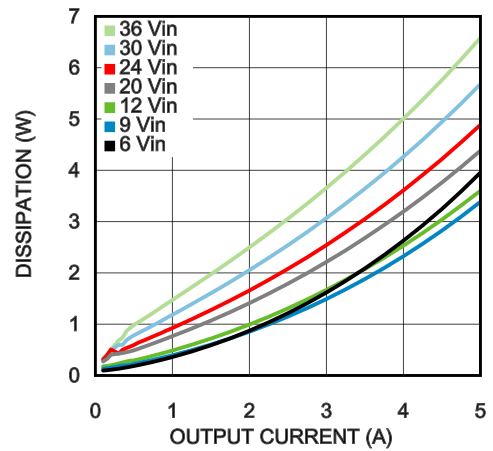

30116957

Efficiency 1.8V Output @ 25°C Ambient

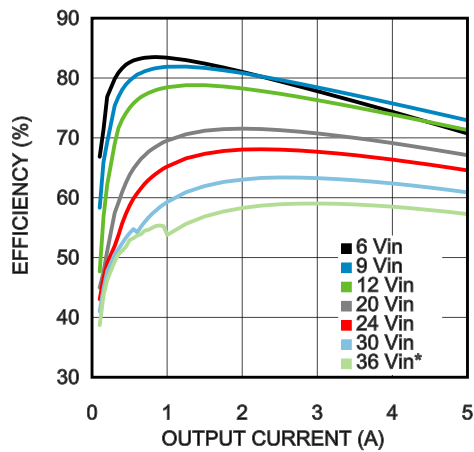

30116958

Dissipation 1.8V Output @ 25°C Ambient

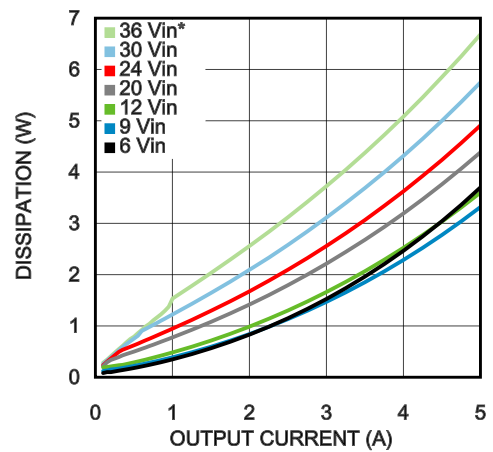

30116959

Efficiency 1.5V Output @ 25°C Ambient

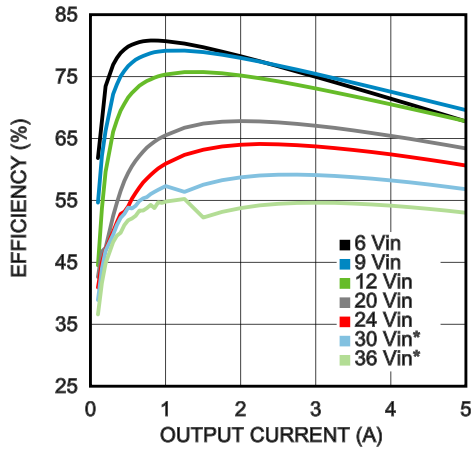

30116960

Dissipation 1.5V Output @ 25°C Ambient

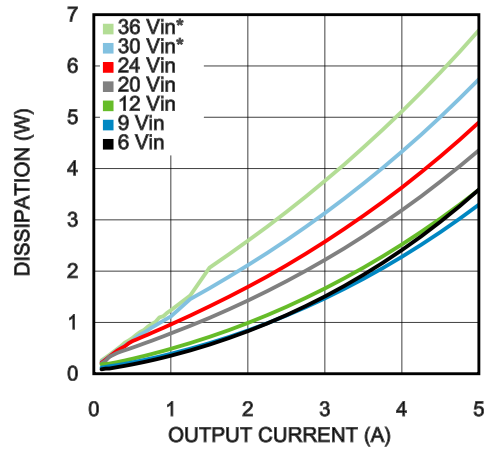

30116961

Efficiency 1.2V Output @ 25°C Ambient

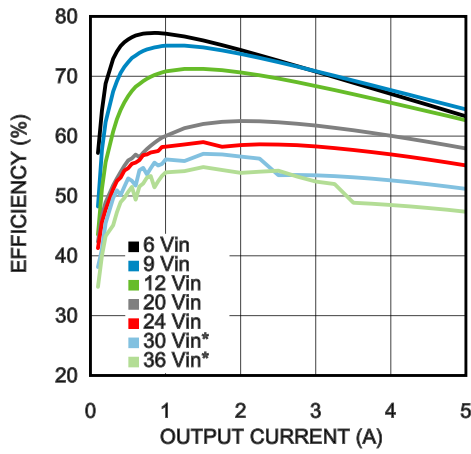

30116962

Dissipation 1.2V Output @ 25°C Ambient

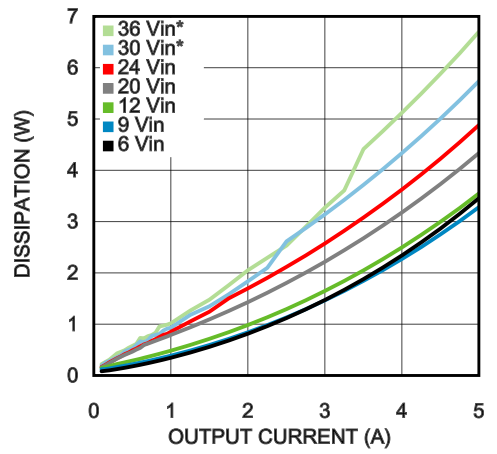

30116963

Efficiency 1.0V Output @ 25°C Ambient

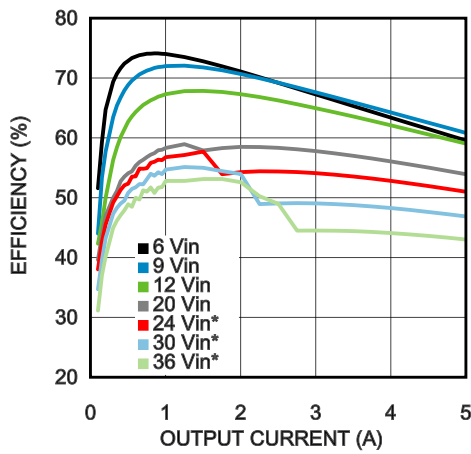

30116964

Dissipation 1.0V Output @ 25°C Ambient

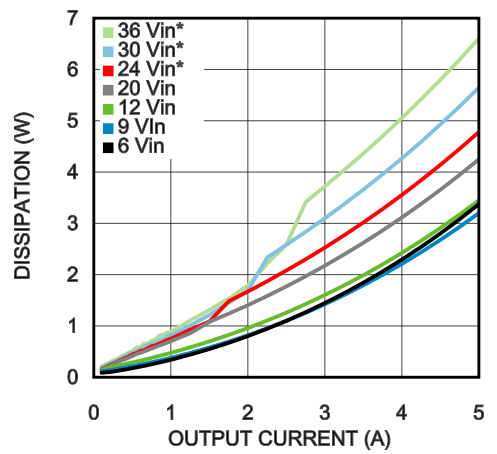

30116965

Efficiency 0.8V Output @ 25°C Ambient

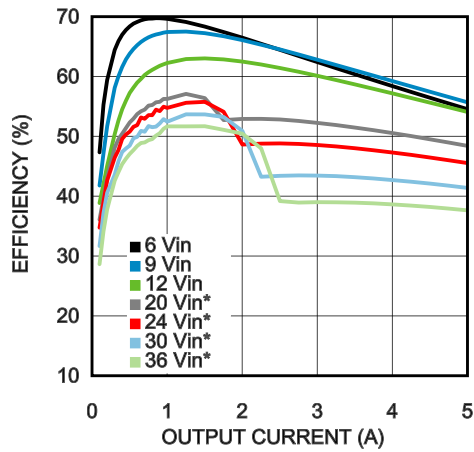

30116990

Dissipation 0.8V Output @ 25°C Ambient

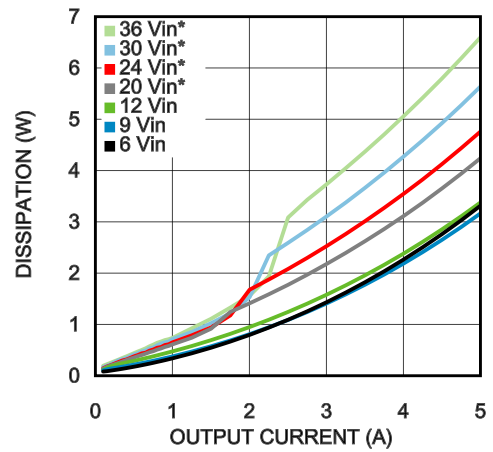

30116991

Efficiency 6.0V Output @ 85°C Ambient

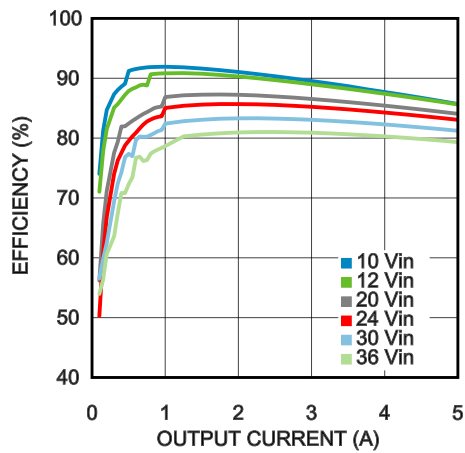

30116926

Dissipation 6.0V Output @ 85°C Ambient

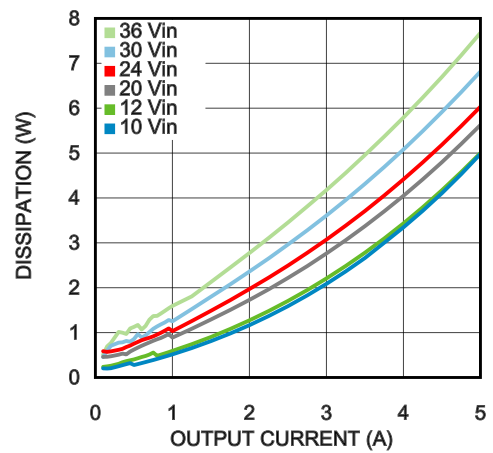

30116927

Efficiency 5.0V Output @ 85°C Ambient

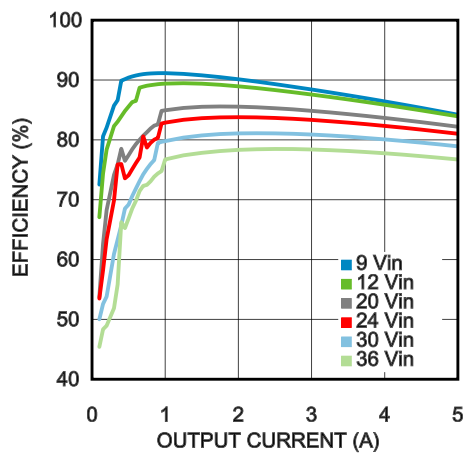

30116928

Dissipation 5.0V Output @ 85°C Ambient

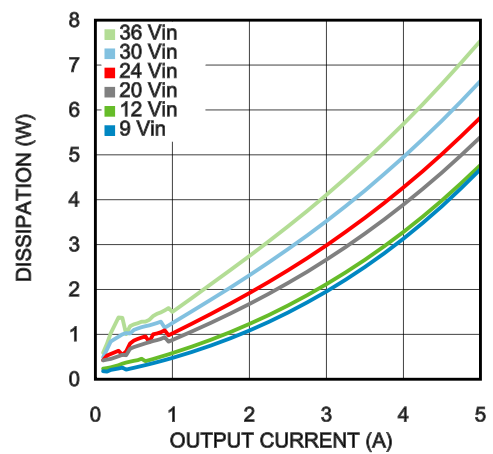

30116929

Efficiency 3.3V Output @ 85°C Ambient

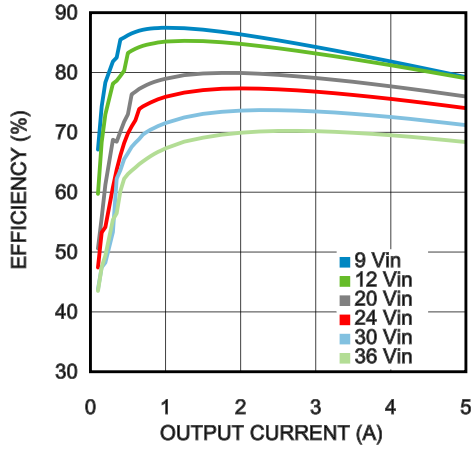

30116930

Dissipation 3.3V Output @ 85°C Ambient

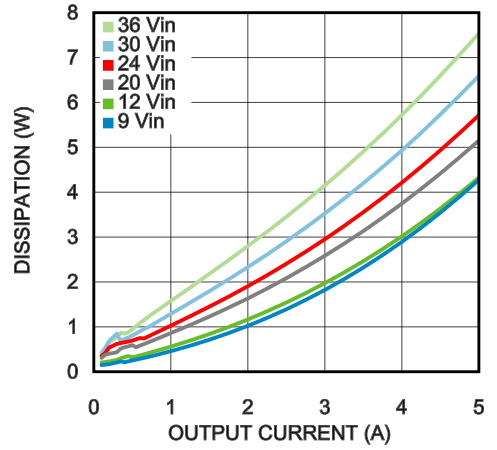

30116931

Efficiency 2.5V Output @ 85°C Ambient

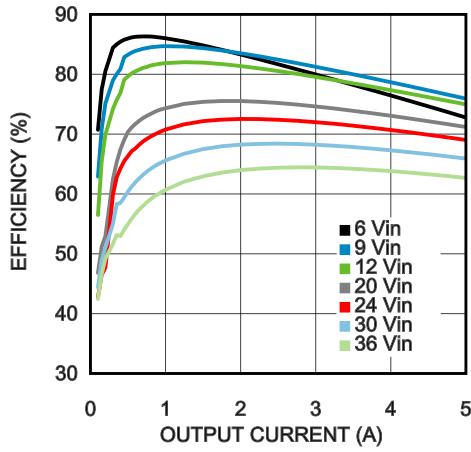

30116932

Dissipation 2.5V Output @ 85°C Ambient

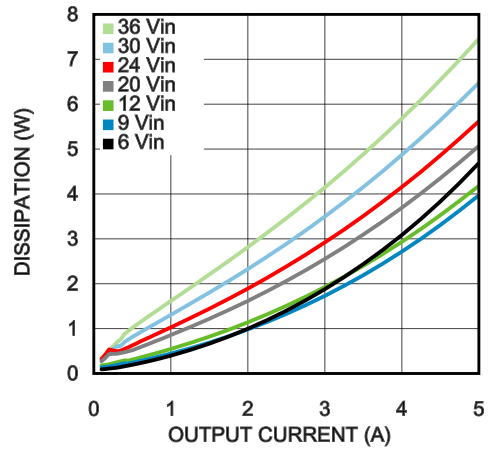

30116933

Efficiency 1.8V Output @ 85°C Ambient

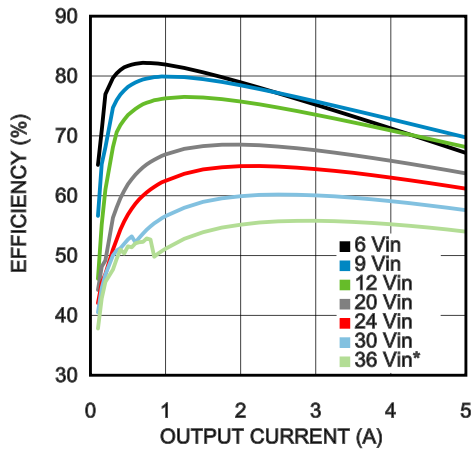

30116934

Dissipation 1.8V Output @ 85°C Ambient

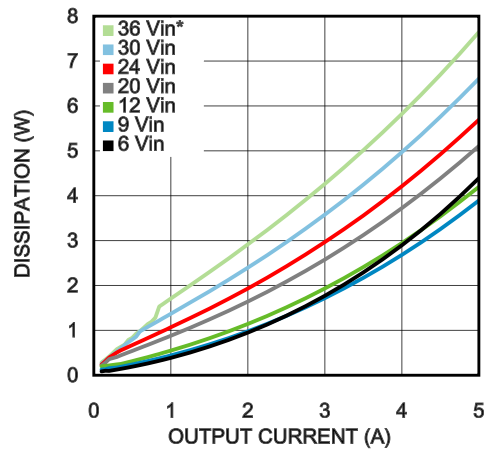

30116935

Efficiency 1.5V Output @ 85°C Ambient

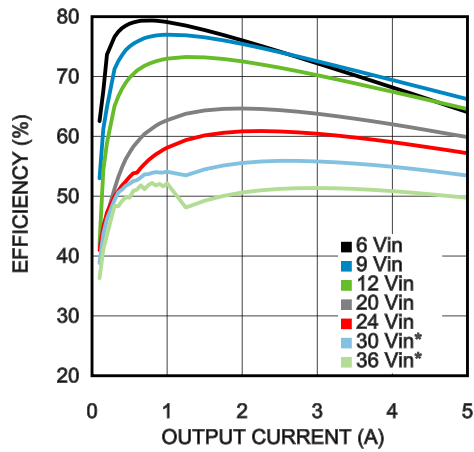

30116936

Dissipation 1.5V Output @ 85°C Ambient

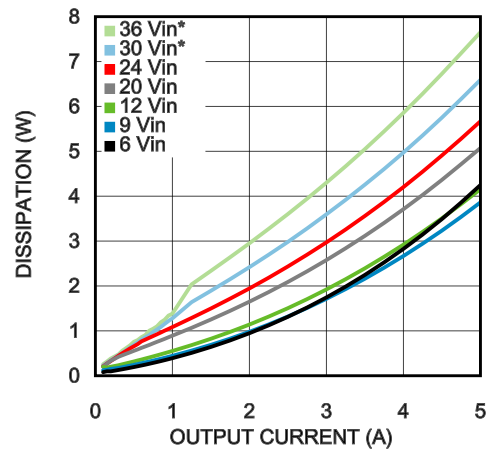

30116937

Efficiency 1.2V Output @ 85°C Ambient

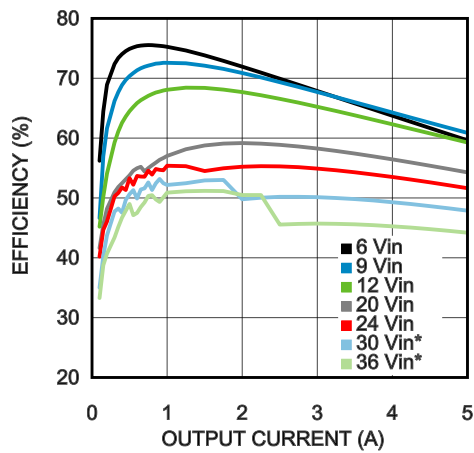

30116938

Dissipation 1.2V Output @ 85°C Ambient

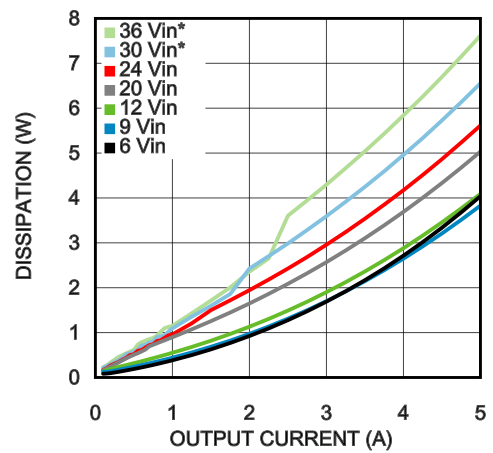

30116939

Efficiency 1.0V Output @ 85°C Ambient

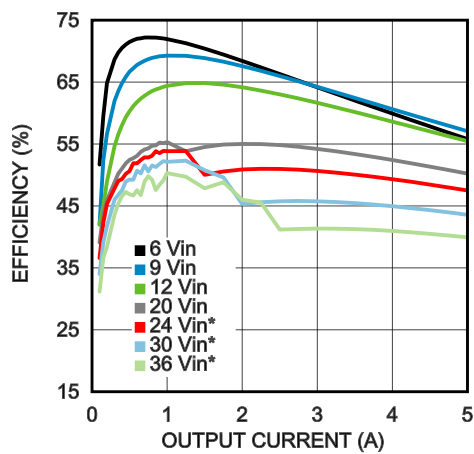

30116940

Dissipation 1.0V Output @ 85°C Ambient

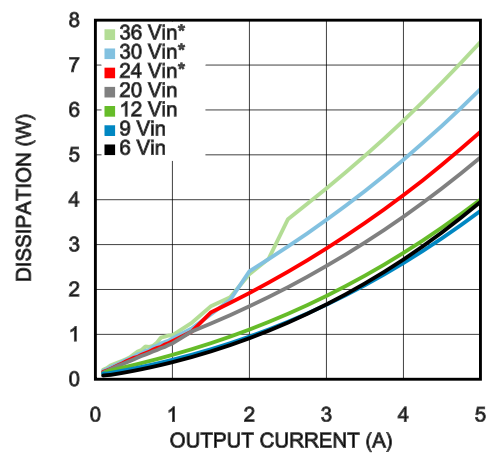

30116941

Efficiency 0.8V Output @ 85°C Ambient

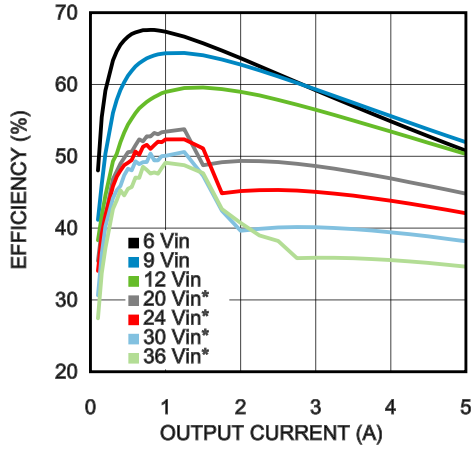

30116992

Dissipation 0.8V Output @ 85°C Ambient

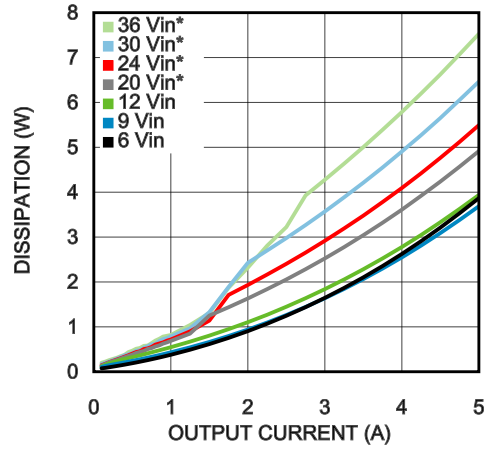

30116993

Thermal derating $V_{IN} = 12V, V_{OUT} = 5.0V$

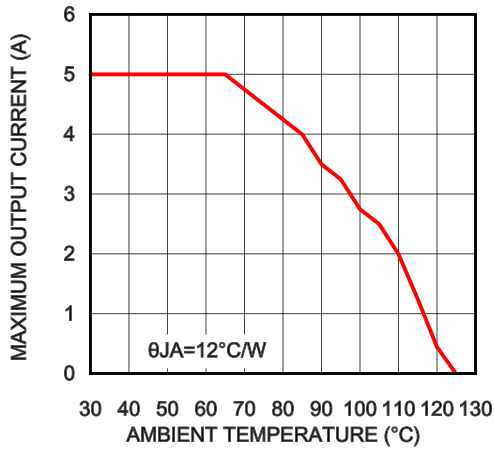

30116989

Thermal derating $V_{IN} = 12V, V_{OUT} = 3.3V$

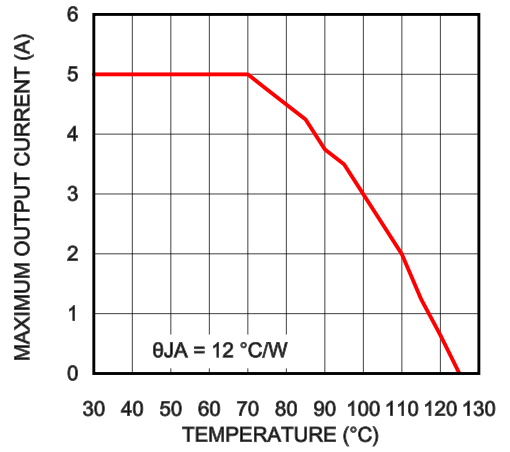

30116994

Thermal derating $V_{IN} = 24V, V_{OUT} = 5.0V$

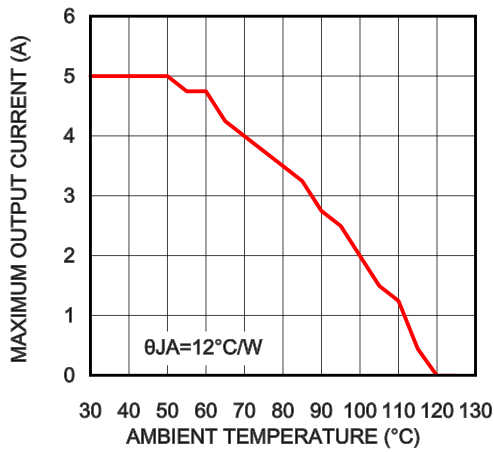

30116996

Thermal derating $V_{IN} = 24V, V_{OUT} = 3.3V$

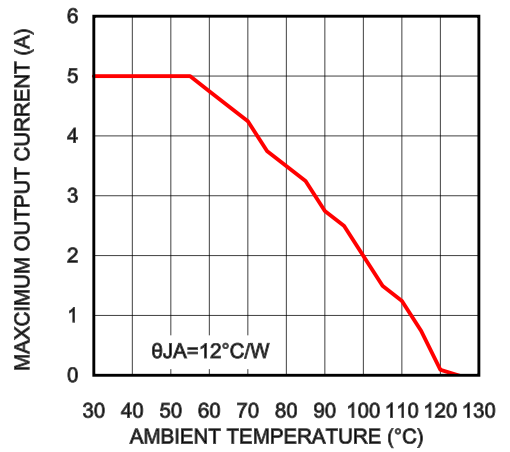

30116997

Normalized Line and load regulation $V_{OUT} = 3.3V$

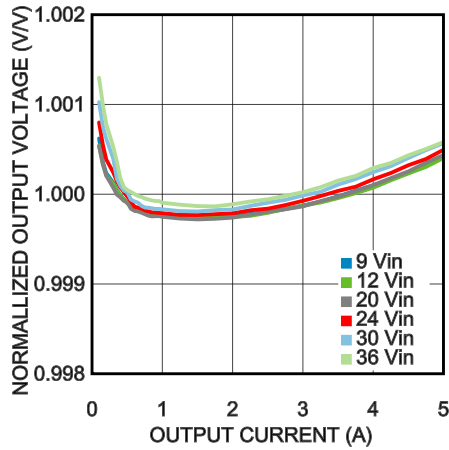

30116942

Output ripple
 $12V_{IN}$ $3.3V_O$ @ 5A, BW = 20 MHz

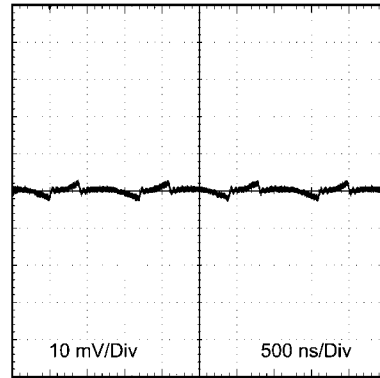

30116905

Output ripple
 $12V_{IN}$ $3.3V_O$ @ 5A BW = 250 MHz

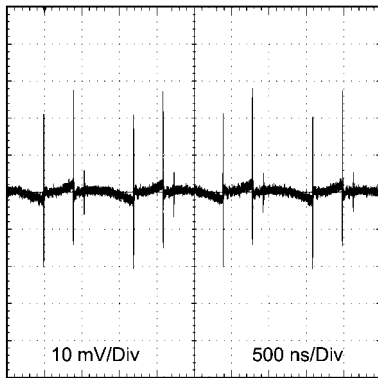

30116906

Transient response
 $12V_{IN}$ $3.3V_O$ 0.5 to 5A Step

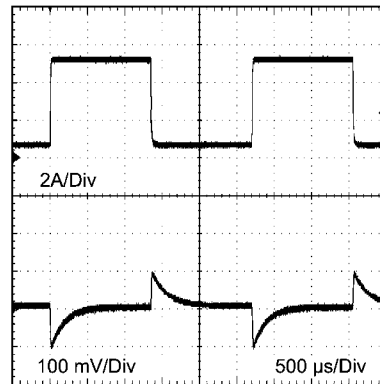

30116908

Short circuit current vs input voltage

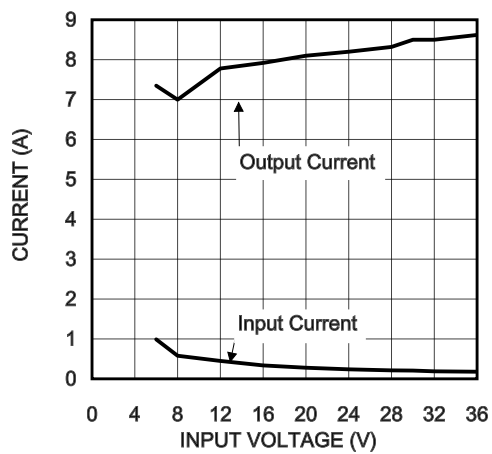

30116918

Block Diagram

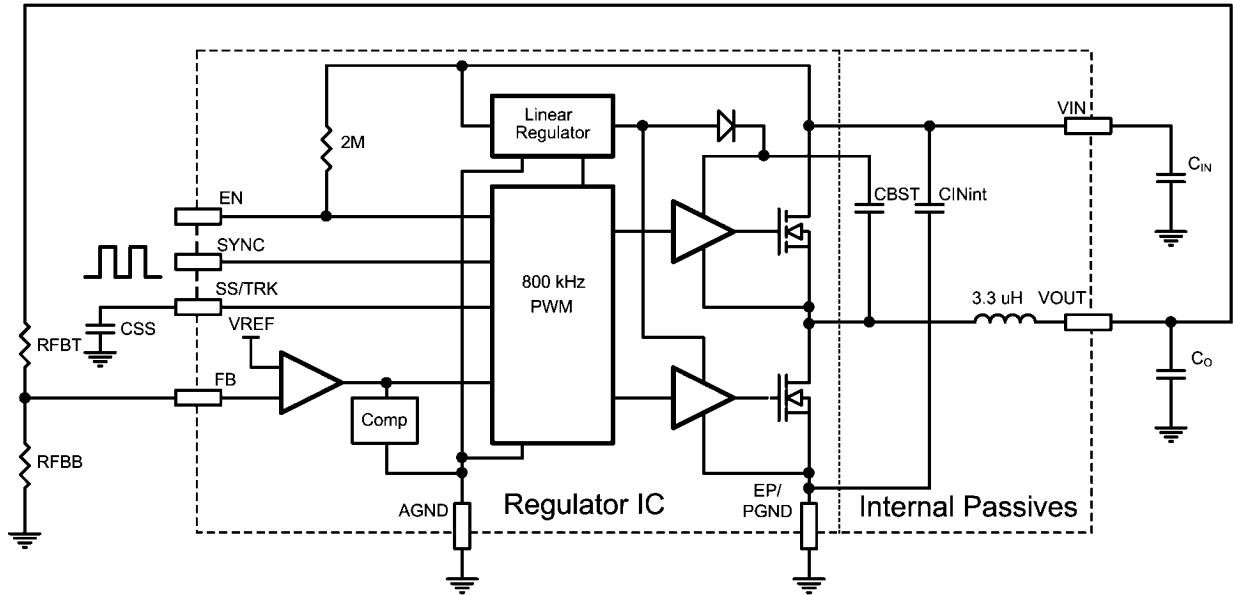

General Description

The LMZ23605 SIMPLE SWITCHER® power module is an easy-to-use step-down DC-DC solution capable of driving up to 5A load. The LMZ23605 is available in an innovative package that enhances thermal performance and allows for hand or machine soldering.

The LMZ23605 can accept an input voltage rail between 6V and 36V and deliver an adjustable and highly accurate output voltage as low as 0.8V. The LMZ23605 only requires two external resistors and three external capacitors to complete the power solution. The LMZ23605 is a reliable and robust design with the following protection features: thermal shutdown, programmable input under-voltage lockout, output over-voltage protection, short-circuit protection, output current limit, and allows startup into a pre-biased output. The sync input allows synchronization over the 650 to 950 kHz switching frequency range.

Design Steps for the LMZ23605 Application

The LMZ23605 is fully supported by Webench® which offers: component selection, electrical and thermal simulations. Additionally there are both evaluation and demonstration boards that may be used as a starting point for design. The following list of steps can be used to manually design the LMZ23605 application.

All references to values refer to the typical applications schematic figure 4.

- Select minimum operating V_{IN} with enable divider resistors
- Program V_O with resistor divider selection
- Select C_O
- Select C_{IN}
- Determine module power dissipation
- Layout PCB for required thermal performance

ENABLE DIVIDER, R_{ENT} , R_{ENB} AND R_{ENH} SELECTION

Internal to the module is a 2 mega ohm pull-up resistor connected from V_{IN} to Enable. For applications not requiring precision under voltage lock out (UVLO), the Enable input may be left open circuit and the internal resistor will always enable the module. In such case, the internal UVLO occurs typically at 4.3V (V_{IN} rising).

In applications with separate supervisory circuits Enable can be directly interfaced to a logic source. In the case of sequencing supplies, the divider is connected to a rail that becomes active earlier in the power-up cycle than the LMZ23605 output rail.

Enable provides a precise 1.279V threshold to allow direct logic drive or connection to a voltage divider from a higher enable voltage such as V_{IN} . Additionally there is 21 μ A(typ) of switched offset current allowing programmable hysteresis. See Figure 1.

The function of the enable divider is to allow the designer to choose an input voltage below which the circuit will be disabled. This implements the feature of programmable UVLO. The two resistors should be chosen based on the following ratio:

$$R_{ENT} / R_{ENB} = (V_{IN\ UVLO} / 1.279V) - 1 \quad (1)$$

The LMZ23605 typical application shows 12.7k Ω for R_{ENB} and 42.2k Ω for R_{ENT} resulting in a rising UVLO of 5.46V. Note that this divider presents 8.33V to the input when the divider is raised to 36V which would exceed the recommended 5.5V limit for Enable. A midpoint 5.1V Zener clamp is applied to allow the application to cover the full 6V to 36V range of operation. The zener clamp is not required if the target application prohibits the maximum Enable input voltage from being exceeded.

Additional enable voltage hysteresis can be added with the inclusion of R_{ENH} . It is possible to select values for R_{ENT} and R_{ENB} such that R_{ENH} is a value of zero allowing it to be omitted from the design.

Rising threshold can be calculated as follows:

$$V_{EN(rising)} = 1.279 (1 + (R_{ENT} || 2\text{ meg}) / R_{ENB})$$

Whereas the falling threshold level can be calculated using:

$$V_{EN(\text{falling})} = V_{EN(\text{rising})} - 21 \mu\text{A} (R_{ENT} \parallel 2 \text{ meg} \parallel R_{ENTB} + R_{ENH})$$

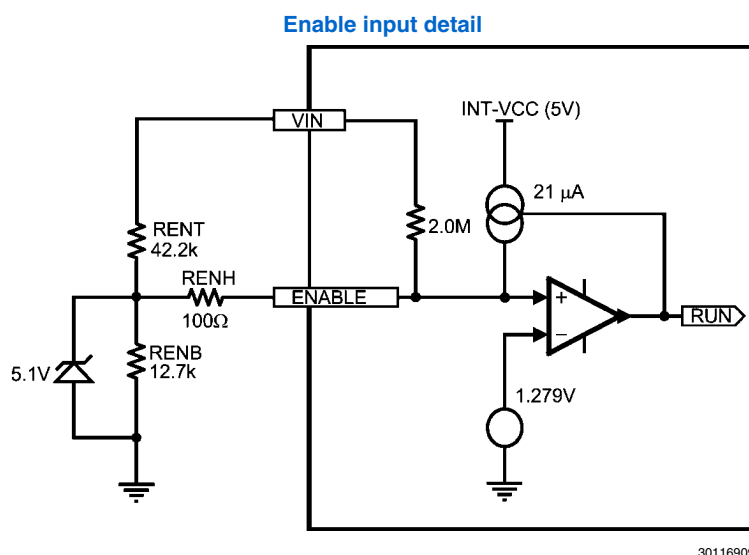

FIGURE 1.

OUTPUT VOLTAGE SELECTION

Output voltage is determined by a divider of two resistors connected between V_O and ground. The midpoint of the divider is connected to the FB input.

The regulated output voltage determined by the external divider resistors R_{FBT} and R_{FBB} is:

$$V_O = 0.796\text{V} * (1 + R_{FBT} / R_{FBB}) \quad (2)$$

Rearranging terms; the ratio of the feedback resistors for a desired output voltage is:

$$R_{FBT} / R_{FBB} = (V_O / 0.796\text{V}) - 1 \quad (3)$$

These resistors should generally be chosen from values in the range of 1.0 k Ω to 10.0 k Ω .

For $V_O = 0.8\text{V}$ the FB pin can be connected to the output directly and R_{FBB} can be set to 8.06k Ω to provide minimum output load.

A table of values for R_{FBT} , and R_{FBB} , is included in the simplified applications schematic on page 2.

SOFT-START CAPACITOR SELECTION

Programmable soft-start permits the regulator to slowly ramp to its steady state operating point after being enabled, thereby reducing current inrush from the input supply and slowing the output voltage rise-time.

Upon turn-on, after all UVLO conditions have been passed, an internal 1.6mSec circuit slowly ramps the SS/TRK input to implement internal soft start. If 2 mSec is an adequate turn-on time then the C_{SS} capacitor can be left unpopulated. Longer soft-start periods are achieved by adding an external capacitor to this input.

Soft start duration is given by the formula:

$$t_{SS} = V_{REF} * C_{SS} / I_{SS} = 0.796\text{V} * C_{SS} / 50\mu\text{A} \quad (4)$$

This equation can be rearranged as follows:

$$C_{SS} = t_{SS} * 50\mu\text{A} / 0.796\text{V} \quad (5)$$

Using a 0.22 μF capacitor results in 3.5 msec typical soft-start duration; and 0.47 μF results in 7.5 msec typical. 0.47 μF is a recommended initial value.

As the soft-start input exceeds 0.796V the output of the power stage will be in regulation and the 50 μA current is deactivated. Note that the following conditions will reset the soft-start capacitor by discharging the SS input to ground with an internal current sink.

- The Enable input being pulled low
- Thermal shutdown condition
- Internal Vcc UVLO (Approx 4.3V input to V_{IN})

TRACKING SUPPLY DIVIDER OPTION

The tracking function allows the module to be connected as a slave supply to a primary voltage rail (often the 3.3V system rail) where the slave module output voltage is lower than that of the master. Proper configuration allows the slave rail to power up coincident with the master rail such that the voltage difference between the rails during ramp-up is small (i.e. <0.15V typ). The values for the tracking resistive divider should be selected such that the effect of the internal 50 μA current source is minimized. In most cases the ratio of the tracking divider resistors is the same as the ratio of the output voltage setting divider. Proper operation in tracking mode dictates the soft-start time of the slave rail be shorter than the master rail; a condition that is easy satisfy since the C_{SS} cap is replaced by R_{TKB} . The tracking function is only supported for the power up interval of the master supply; once the SS/TRK rises past 0.8V the input is no longer enabled and the 50 μA internal current source is switched off.

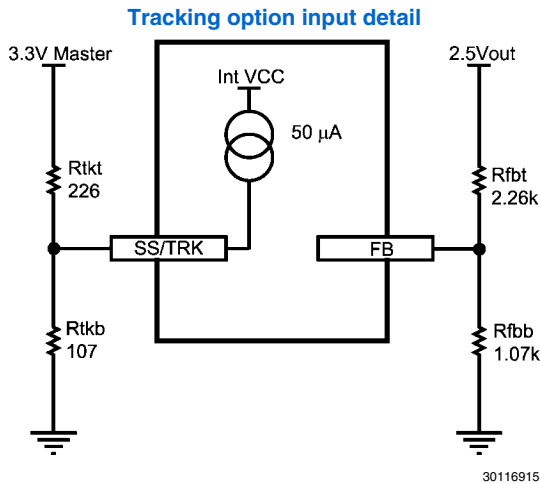

FIGURE 2.

C_O SELECTION

None of the required C_O output capacitance is contained within the module. A minimum value of 200 μF is required based on the values of internal compensation in the error amplifier. Low ESR tantalum, organic semiconductor or specialty polymer capacitor types are recommended for obtaining lowest ripple. The output capacitor C_O may consist of several capacitors in parallel placed in close proximity to the module. The output capacitor assembly must also meet the worst case minimum ripple current rating of 0.5 * I_{LR P-P}, as calculated in equation (14) below. Beyond that, additional capacitance will reduce output ripple so long as the ESR is low enough to permit it. Loop response verification is also valuable to confirm closed loop behavior.

For applications with dynamic load steps; the following equation provides a good first pass approximation of C_O for load transient requirements. Where V_{O-Tran} is 100mV on a 3.3V output design.

$$C_O \geq I_{O-Tran} / ((V_{O-Tran} - ESR * I_{O-Tran}) * (F_{sw} / V_O)) \quad (6)$$

Solving:

$$C_O \geq 4.5A / ((0.1V - .007 * 4.5) * (800000 / 3.3)) \geq 271 \mu F \quad (7)$$

Note that the stability requirement for 200 μF minimum output capacitance will take precedence.

One recommended output capacitor combination is a 220μF, 7 milliohm ESR specialty polymer cap in parallel with a 100 uF 6.3V X5R ceramic. This combination provides excellent performance that may exceed the requirements of certain applications. Additionally some small ceramic capacitors can be used for high frequency EMI suppression.

C_{IN} SELECTION

The LMZ23605 module contains a small amount of internal ceramic input capacitors. Additional input capacitance is required external to the module to handle the input ripple current of the application. The input capacitor can be several capacitors in parallel. This input capacitance should be located in very close proximity to the module. Input capacitor selection is generally directed to satisfy the input ripple current requirements rather than by capacitance value. Input ripple current rating is dictated by the equation:

$$I(C_{IN(RMS)}) \approx 1/2 * I_O * \text{SQRT}(D / 1-D) \quad (8)$$

where $D \approx V_O / V_{IN}$

(As a point of reference, the worst case ripple current will occur when the module is presented with full load current and when $V_{IN} = 2 * V_O$).

Recommended minimum input capacitance is 22uF X7R (or X5R) ceramic with a voltage rating at least 25% higher than the maximum applied input voltage for the application. It is also recommended that attention be paid to the voltage and temperature derating of the capacitor selected. It should be noted that ripple current rating of ceramic capacitors may be missing from the capacitor data sheet and you may have to contact the capacitor manufacturer for this parameter.

If the system design requires a certain minimum value of peak-to-peak input ripple voltage (ΔV_{IN}) be maintained then the following equation may be used.

$$C_{IN} \geq I_O * D * (1-D) / f_{SW-CCM} * \Delta V_{IN} \quad (9)$$

If ΔV_{IN} is 1% of V_{IN} for a 12V input to 3.3V output application this equals 120 mV and $f_{SW} = 812$ kHz.

$$C_{IN} \geq 5A * 3.3V/12V * (1 - 3.3V/12V) / (812000 * 0.12 V) \geq 10.2 \mu F$$

Additional bulk capacitance with higher ESR may be required to damp any resonant effects of the input capacitance and parasitic inductance of the incoming supply lines. The LMZ23605 typical applications schematic and evaluation board include a 150 μF 50V aluminum capacitor for this function. There are many situations where this capacitor is not necessary.

POWER DISSIPATION AND BOARD THERMAL REQUIREMENTS

When calculating module dissipation use the maximum input voltage and the average output current for the application. Many common operating conditions are provided in the characteristic curves such that less common applications can be derived through interpolation. In all designs, the junction temperature must be kept below the rated maximum of 125°C.

For the design case of $V_{IN} = 24V$, $V_O = 3.3V$, $I_O = 5A$, and $T_{AMB(MAX)} = 85^\circ C$, the module must see a thermal resistance from case to ambient of less than:

$$\theta_{CA} < (T_{J-MAX} - T_{A-MAX}) / P_{IC-LOSS} - \theta_{JC} \quad (10)$$

Given the typical thermal resistance from junction to case to be 1.9 °C/W. Use the 85°C power dissipation curves in the Typical Performance Characteristics section to estimate the $P_{IC-LOSS}$ for the application being designed. In this application it is 5.5W. (Note that for package dissipations above 5W air flow or external heat sinking may be required.)

$$\theta_{CA} = (125 - 85) / 5.5W - 1.9 = 5.37 \quad (11)$$

To reach $\theta_{CA} = 5.37$., the PCB is required to dissipate heat effectively. With no airflow and no external heat-sink, a good estimate of the required board area covered by 2 oz. copper on both the top and bottom metal layers is:

$$\text{Board_Area_cm}^2 = 500^\circ C * \text{cm}^2/W / \theta_{CA} \quad (12)$$

As a result, approximately 93 square cm of 2 oz copper on top and bottom layers is required for the PCB design. The PCB copper heat sink must be connected to the exposed pad. Approximately sixty, 10mil (254 μm) thermal vias spaced 39 mils (1.0 mm) apart connect the top copper to the bottom copper. For an example of a high thermal performance PCB layout for SIMPLE SWITCHER® power modules, refer to AN-2085, AN-2125, AN-2020 and AN-2026.

PC BOARD LAYOUT GUIDELINES

PC board layout is an important part of DC-DC converter design. Poor board layout can disrupt the performance of a DC-DC converter and surrounding circuitry by contributing to EMI, ground bounce and resistive voltage drop in the traces. These can send erroneous signals to the DC-DC converter resulting in poor regulation or instability. Good layout can be implemented by following a few simple design rules. A good example layout is shown in Figure 5.

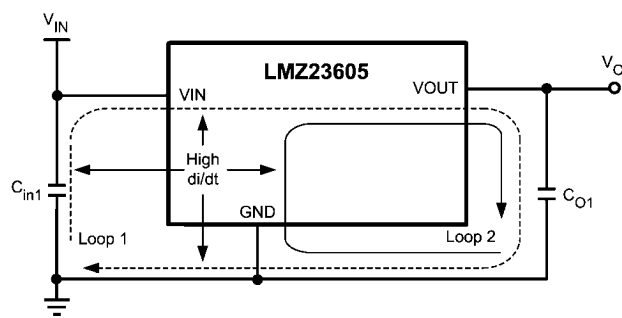

30116911

FIGURE 3.

1. Minimize area of switched current loops.

From an EMI reduction standpoint, it is imperative to minimize the high di/dt paths during PC board layout as shown in the figure above. The high current loops that do not overlap have high di/dt content that will cause observable high frequency noise on the output pin if the input capacitor (C_{in1}) is placed at a distance away from the LMZ23605. Therefore place C_{in1} as close as possible to the LMZ23605 VIN and PGND exposed pad. This will minimize the high di/dt area and reduce radiated EMI. Additionally, grounding for both the input and output capacitor should consist of a localized top side plane that connects to the PGND exposed pad (EP).

2. Have a single point ground.

The ground connections for the feedback, soft-start, and enable components should be routed to the AGND pin of the device. This prevents any switched or load currents from flowing in the analog ground traces. If not properly handled, poor grounding can result in degraded load regulation or erratic output voltage ripple behavior. Additionally provide the single point ground connection from pin 4 (AGND) to EP/PGND.

3. Minimize trace length to the FB pin.

Both feedback resistors, R_{FBT} and R_{FBB} should be located close to the FB pin. Since the FB node is high impedance, maintain the copper area as small as possible. The traces from R_{FBT} , R_{FBB} should be routed away from the body of the LMZ23605 to minimize possible noise pickup.

4. Make input and output bus connections as wide as possible.

This reduces any voltage drops on the input or output of the converter and maximizes efficiency. To optimize voltage accuracy at the load, ensure that a separate feedback voltage sense trace is made to the load. Doing so will correct for voltage drops and provide optimum output accuracy.

5. Provide adequate device heat-sinking.

Use an array of heat-sinking vias to connect the exposed pad to the ground plane on the bottom PCB layer. If the PCB has a plurality of copper layers, these thermal vias can also be employed to make connection to inner layer heat-spreading

ground planes. For best results use a 6 x 10 via array with minimum via diameter of 10mils (254 μ m) thermal vias spaced 39mils (1.0 mm). Ensure enough copper area is used for heat-sinking to keep the junction temperature below 125°C.

Additional Features

SYNCHRONIZATION INPUT

The PWM switching frequency can be synchronized to an external frequency source. If this feature is not used, connect this input either directly to ground, or connect to ground through a resistor of 1.5 k Ω ohm or less. The allowed synchronization frequency range is 650kHz to 950 kHz. The typical input threshold is 1.4V transition level. Ideally the input clock should overdrive the threshold by a factor of 2, so direct drive from 3.3V logic via a 1.5k Ω Thevenin source resistance is recommended. Note that applying a sustained "logic 1" corresponds to zero hertz PWM frequency and will cause the module to stop switching.

OUTPUT OVER-VOLTAGE PROTECTION

If the voltage at FB is greater than a 0.86V internal reference, the output of the error amplifier is pulled toward ground, causing V_O to fall.

CURRENT LIMIT

The LMZ23605 is protected by both low side (LS) and high side (HS) current limit circuitry. The LS current limit detection is carried out during the off-time by monitoring the current through the LS synchronous MOSFET. Referring to the Functional Block Diagram, when the top MOSFET is turned off, the inductor current flows through the load, the PGND pin and the internal synchronous MOSFET. If this current exceeds 5.4A (typical) the current limit comparator disables the start of the next switching period. Switching cycles are prohibited until current drops below the limit. It should also be noted that d.c. current limit is dependent on both duty cycle as illustrated in the graph in the typical performance section. The HS current limit monitors the current of top side MOSFET. Once HS current limit is detected (7A typical), the HS MOSFET is shut off immediately, until the next cycle. Exceeding HS current limit causes V_O to fall. Typical behavior of exceeding LS current limit is that f_{sw} drops to 1/2 of the operating frequency.

THERMAL PROTECTION

The junction temperature of the LMZ23605 should not be allowed to exceed its maximum ratings. Thermal protection is implemented by an internal Thermal Shutdown circuit which activates at 165 °C (typ) causing the device to enter a low power standby state. In this state the main MOSFET remains off causing V_O to fall, and additionally the C_{SS} capacitor is discharged to ground. Thermal protection helps prevent catastrophic failures for accidental device overheating. When the junction temperature falls back below 150 °C (typ Hyst = 15°C) the SS pin is released, V_O rises smoothly, and normal operation resumes.

Applications requiring maximum output current especially those at high input voltage may require additional derating at elevated temperatures.

PRE-BIASED STARTUP

The LMZ23605 will properly start up into a pre-biased output. This startup situation is common in multiple rail logic applications where current paths may exist between different power rails during the startup sequence. The following scope capture shows proper behavior in this mode. Trace one is Enable

going high. Trace two is 1.5V pre-bias rising to 3.3V. Risetime determined by C_{SS} , trace three.

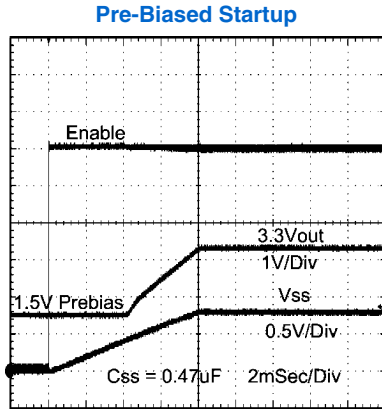

DISCONTINUOUS CONDUCTION AND CONTINUOUS CONDUCTION MODES

At light load the regulator will operate in discontinuous conduction mode (DCM). With load currents above the critical conduction point, it will operate in continuous conduction mode (CCM). In CCM, current flows through the inductor through the entire switching cycle and never falls to zero during the off-time. When operating in DCM, inductor current is maintained to an average value equaling I_{out} . Inductor current exhibits normal behavior for the emulated current mode control method used. Output voltage ripple typically increases during this mode of operation.

Following is a comparison pair of waveforms of the showing both CCM (upper) and DCM operating modes.

CCM and DCM Operating Modes

$V_{IN} = 12V$, $V_O = 3.3V$, $I_O = 3A/0.3A$ 2 $\mu\text{sec/div}$

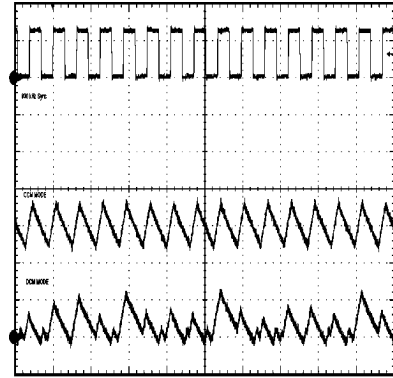

30116912

The approximate formula for determining the DCM/CCM boundary is as follows:

$$I_{DCB} \approx V_O * (V_{IN} - V_O) / (2 * 3.3 \mu\text{H} * f_{SW(CCM)} * V_{IN}) \quad (13)$$

The inductor internal to the module is 3.3 μH . This value was chosen as a good balance between low and high input voltage applications. The main parameter affected by the inductor is the amplitude of the inductor ripple current (I_{LR}). I_{LR} can be calculated with:

$$I_{LR P-P} = V_O * (V_{IN} - V_O) / (3.3 \mu\text{H} * f_{SW} * V_{IN}) \quad (14)$$

Where V_{IN} is the maximum input voltage and f_{SW} is typically 812 kHz.

If the output current I_O is determined by assuming that $I_O = I_L$, the higher and lower peak of I_{LR} can be determined.

Typical Application Schematic Diagram

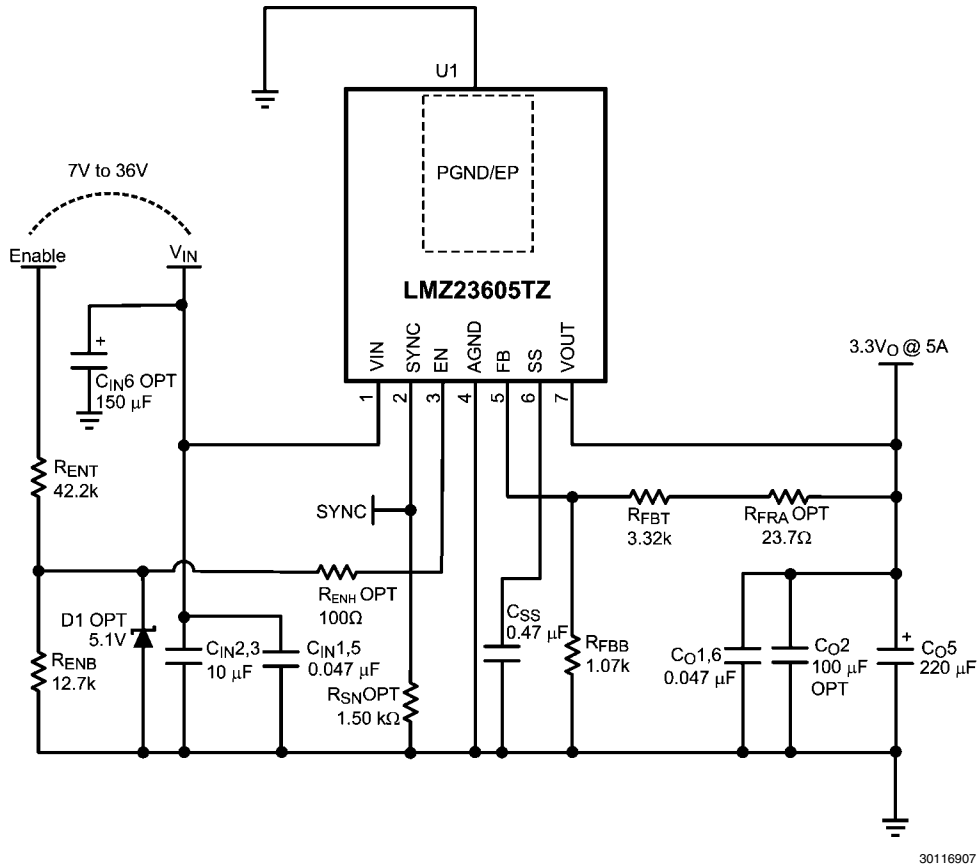

FIGURE 4.

TABLE 1. Typical Application Bill of Materials

Ref Des	Description	Case Size	Manufacturer	Manufacturer P/N
U1	SIMPLE SWITCHER®	TO-PMOD-7	National Semiconductor	LMZ23605TZ
C _{in1,5}	0.047 µF, 50V, X7R	1206	Yageo America	CC1206KRX7R9BB473
C _{in2,3}	10 µF, 50V, X7R	1210	Taiyo Yuden	UMK325BJ106MM-T
C _{in6} (OPT)	CAP, AL, 150µF, 50V	Radial G	Panasonic	EEE-FK1H151P
C _{O1,6}	0.047 µF, 50V, X7R	1206	Yageo America	CC1206KRX7R9BB473
C _{O2} (OPT)	100 µF, 6.3V, X7R	1210	TDK	C3225X5R0J107M
C _{O5}	220 µF, 6.3V, SP-Cap	(7343)	Panasonic	EEF-UE0J221LR
R _{FBT}	3.32 kΩ	0805	Panasonic	ERJ-6ENF3321V
R _{FBB}	1.07 kΩ	0805	Panasonic	ERJ-6ENF1071V
R _{SN} (OPT)	1.50 kΩ	0805	Vishay Dale	CRCW08051K50FKEA
R _{ENT}	42.2 kΩ	0805	Panasonic	ERJ-6ENF4222V
R _{ENB}	12.7 kΩ	0805	Panasonic	ERJ-6ENF1272V
R _{FRA} (OPT)	23.7Ω	0805	Vishay Dale	CRCW080523R7FKEA
R _{ENH} (OPT)	100 Ω	0805	Vishay Dale	CRCW0805100RFKEA
C _{SS}	0.47 µF, ±10%, X7R, 16V	0805	AVX	0805YC474KAT2A
D1(OPT)	5.1V, 0.5W	SOD-123	Diodes Inc.	MMSZ5231BS-7-F

Table 1

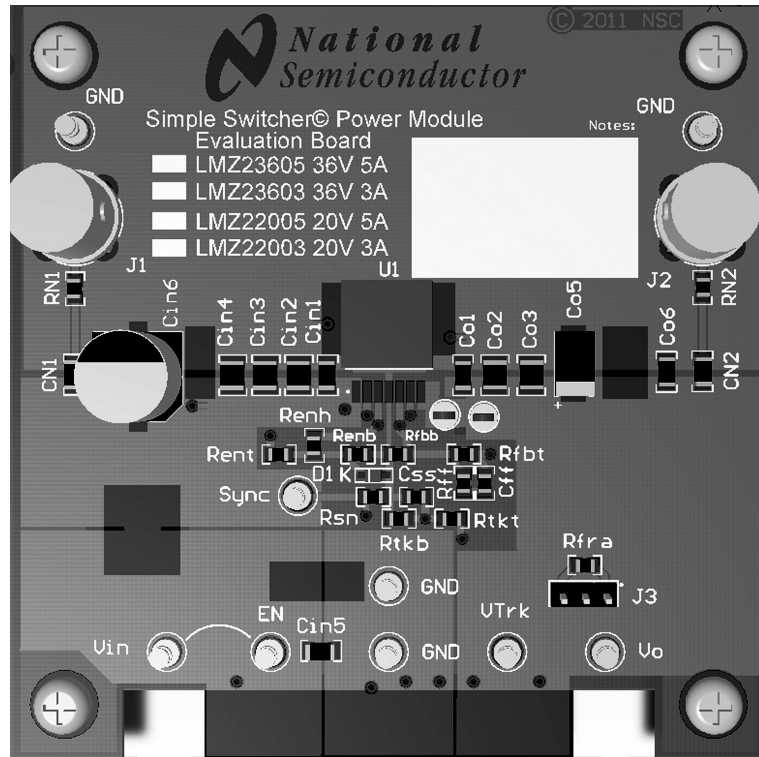

FIGURE 5. Top View Evaluation Board – See AN-2085

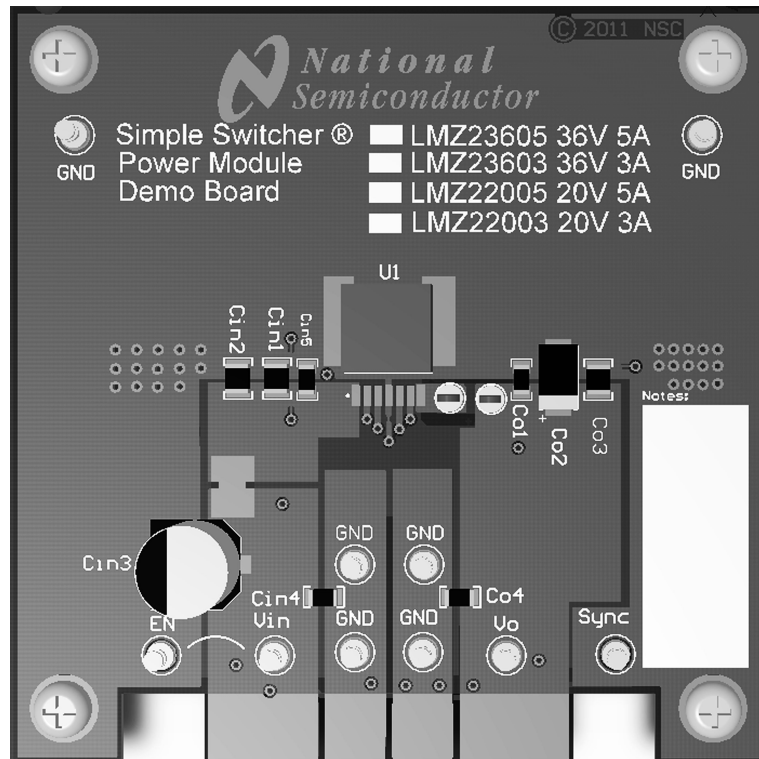

FIGURE 6. Top View Demonstration Board – See AN-2125

Notes

For more National Semiconductor product information and proven design tools, visit the following Web sites at:
www.national.com

Products		Design Support	
Amplifiers	www.national.com/amplifiers	WEBENCH® Tools	www.national.com/webench
Audio	www.national.com/audio	App Notes	www.national.com/appnotes
Clock and Timing	www.national.com/timing	Reference Designs	www.national.com/refdesigns
Data Converters	www.national.com/adc	Samples	www.national.com/samples
Interface	www.national.com/interface	Eval Boards	www.national.com/evalboards
LVDS	www.national.com/lvds	Packaging	www.national.com/packaging
Power Management	www.national.com/power	Green Compliance	www.national.com/quality/green
Switching Regulators	www.national.com/switchers	Distributors	www.national.com/contacts
LDOs	www.national.com/ldo	Quality and Reliability	www.national.com/quality
LED Lighting	www.national.com/led	Feedback/Support	www.national.com/feedback
Voltage References	www.national.com/vref	Design Made Easy	www.national.com/easy
PowerWise® Solutions	www.national.com/powerwise	Applications & Markets	www.national.com/solutions
Serial Digital Interface (SDI)	www.national.com/sdi	Mil/Aero	www.national.com/milaero
Temperature Sensors	www.national.com/tempensors	SolarMagic™	www.national.com/solarmagic
PLL/VCO	www.national.com/wireless	PowerWise® Design University	www.national.com/training

THE CONTENTS OF THIS DOCUMENT ARE PROVIDED IN CONNECTION WITH NATIONAL SEMICONDUCTOR CORPORATION ("NATIONAL") PRODUCTS. NATIONAL MAKES NO REPRESENTATIONS OR WARRANTIES WITH RESPECT TO THE ACCURACY OR COMPLETENESS OF THE CONTENTS OF THIS PUBLICATION AND RESERVES THE RIGHT TO MAKE CHANGES TO SPECIFICATIONS AND PRODUCT DESCRIPTIONS AT ANY TIME WITHOUT NOTICE. NO LICENSE, WHETHER EXPRESS, IMPLIED, ARISING BY ESTOPPEL OR OTHERWISE, TO ANY INTELLECTUAL PROPERTY RIGHTS IS GRANTED BY THIS DOCUMENT.

TESTING AND OTHER QUALITY CONTROLS ARE USED TO THE EXTENT NATIONAL DEEMS NECESSARY TO SUPPORT NATIONAL'S PRODUCT WARRANTY. EXCEPT WHERE MANDATED BY GOVERNMENT REQUIREMENTS, TESTING OF ALL PARAMETERS OF EACH PRODUCT IS NOT NECESSARILY PERFORMED. NATIONAL ASSUMES NO LIABILITY FOR APPLICATIONS ASSISTANCE OR BUYER PRODUCT DESIGN. BUYERS ARE RESPONSIBLE FOR THEIR PRODUCTS AND APPLICATIONS USING NATIONAL COMPONENTS. PRIOR TO USING OR DISTRIBUTING ANY PRODUCTS THAT INCLUDE NATIONAL COMPONENTS, BUYERS SHOULD PROVIDE ADEQUATE DESIGN, TESTING AND OPERATING SAFEGUARDS.

EXCEPT AS PROVIDED IN NATIONAL'S TERMS AND CONDITIONS OF SALE FOR SUCH PRODUCTS, NATIONAL ASSUMES NO LIABILITY WHATSOEVER, AND NATIONAL DISCLAIMS ANY EXPRESS OR IMPLIED WARRANTY RELATING TO THE SALE AND/OR USE OF NATIONAL PRODUCTS INCLUDING LIABILITY OR WARRANTIES RELATING TO FITNESS FOR A PARTICULAR PURPOSE, MERCHANTABILITY, OR INFRINGEMENT OF ANY PATENT, COPYRIGHT OR OTHER INTELLECTUAL PROPERTY RIGHT.

LIFE SUPPORT POLICY

NATIONAL'S PRODUCTS ARE NOT AUTHORIZED FOR USE AS CRITICAL COMPONENTS IN LIFE SUPPORT DEVICES OR SYSTEMS WITHOUT THE EXPRESS PRIOR WRITTEN APPROVAL OF THE CHIEF EXECUTIVE OFFICER AND GENERAL COUNSEL OF NATIONAL SEMICONDUCTOR CORPORATION. As used herein:

Life support devices or systems are devices which (a) are intended for surgical implant into the body, or (b) support or sustain life and whose failure to perform when properly used in accordance with instructions for use provided in the labeling can be reasonably expected to result in a significant injury to the user. A critical component is any component in a life support device or system whose failure to perform can be reasonably expected to cause the failure of the life support device or system or to affect its safety or effectiveness.

National Semiconductor and the National Semiconductor logo are registered trademarks of National Semiconductor Corporation. All other brand or product names may be trademarks or registered trademarks of their respective holders.

Copyright© 2011 National Semiconductor Corporation

For the most current product information visit us at www.national.com



National Semiconductor
Americas Technical
Support Center
Email: support@nsc.com
Tel: 1-800-272-9959

National Semiconductor Europe
Technical Support Center
Email: europe.support@nsc.com

National Semiconductor Asia
Pacific Technical Support Center
Email: ap.support@nsc.com

National Semiconductor Japan
Technical Support Center
Email: jpn.feedback@nsc.com

IMPORTANT NOTICE

Texas Instruments Incorporated and its subsidiaries (TI) reserve the right to make corrections, modifications, enhancements, improvements, and other changes to its products and services at any time and to discontinue any product or service without notice. Customers should obtain the latest relevant information before placing orders and should verify that such information is current and complete. All products are sold subject to TI's terms and conditions of sale supplied at the time of order acknowledgment.

TI warrants performance of its hardware products to the specifications applicable at the time of sale in accordance with TI's standard warranty. Testing and other quality control techniques are used to the extent TI deems necessary to support this warranty. Except where mandated by government requirements, testing of all parameters of each product is not necessarily performed.

TI assumes no liability for applications assistance or customer product design. Customers are responsible for their products and applications using TI components. To minimize the risks associated with customer products and applications, customers should provide adequate design and operating safeguards.

TI does not warrant or represent that any license, either express or implied, is granted under any TI patent right, copyright, mask work right, or other TI intellectual property right relating to any combination, machine, or process in which TI products or services are used. Information published by TI regarding third-party products or services does not constitute a license from TI to use such products or services or a warranty or endorsement thereof. Use of such information may require a license from a third party under the patents or other intellectual property of the third party, or a license from TI under the patents or other intellectual property of TI.

Reproduction of TI information in TI data books or data sheets is permissible only if reproduction is without alteration and is accompanied by all associated warranties, conditions, limitations, and notices. Reproduction of this information with alteration is an unfair and deceptive business practice. TI is not responsible or liable for such altered documentation. Information of third parties may be subject to additional restrictions.

Resale of TI products or services with statements different from or beyond the parameters stated by TI for that product or service voids all express and any implied warranties for the associated TI product or service and is an unfair and deceptive business practice. TI is not responsible or liable for any such statements.

TI products are not authorized for use in safety-critical applications (such as life support) where a failure of the TI product would reasonably be expected to cause severe personal injury or death, unless officers of the parties have executed an agreement specifically governing such use. Buyers represent that they have all necessary expertise in the safety and regulatory ramifications of their applications, and acknowledge and agree that they are solely responsible for all legal, regulatory and safety-related requirements concerning their products and any use of TI products in such safety-critical applications, notwithstanding any applications-related information or support that may be provided by TI. Further, Buyers must fully indemnify TI and its representatives against any damages arising out of the use of TI products in such safety-critical applications.

TI products are neither designed nor intended for use in military/aerospace applications or environments unless the TI products are specifically designated by TI as military-grade or "enhanced plastic." Only products designated by TI as military-grade meet military specifications. Buyers acknowledge and agree that any such use of TI products which TI has not designated as military-grade is solely at the Buyer's risk, and that they are solely responsible for compliance with all legal and regulatory requirements in connection with such use.

TI products are neither designed nor intended for use in automotive applications or environments unless the specific TI products are designated by TI as compliant with ISO/TS 16949 requirements. Buyers acknowledge and agree that, if they use any non-designated products in automotive applications, TI will not be responsible for any failure to meet such requirements.

Following are URLs where you can obtain information on other Texas Instruments products and application solutions:

Products

Audio	www.ti.com/audio
Amplifiers	amplifier.ti.com
Data Converters	dataconverter.ti.com
DLP® Products	www.dlp.com
DSP	dsp.ti.com
Clocks and Timers	www.ti.com/clocks
Interface	interface.ti.com
Logic	logic.ti.com
Power Mgmt	power.ti.com
Microcontrollers	microcontroller.ti.com
RFID	www.ti-rfid.com
OMAP Mobile Processors	www.ti.com/omap
Wireless Connectivity	www.ti.com/wirelessconnectivity

Applications

Communications and Telecom	www.ti.com/communications
Computers and Peripherals	www.ti.com/computers
Consumer Electronics	www.ti.com/consumer-apps
Energy and Lighting	www.ti.com/energy
Industrial	www.ti.com/industrial
Medical	www.ti.com/medical
Security	www.ti.com/security
Space, Avionics and Defense	www.ti.com/space-avionics-defense
Transportation and Automotive	www.ti.com/automotive
Video and Imaging	www.ti.com/video

TI E2E Community Home Page

e2e.ti.com

Mailing Address: Texas Instruments, Post Office Box 655303, Dallas, Texas 75265
Copyright © 2011, Texas Instruments Incorporated